

Rotary Damper Actuator Standard 10 Nm Modulating Control



- NACM...10 (S1) series
- NENUTEC standard damper actuators are especially designed and produced for applications in the HVAC systems.
- Our wide range of NENUTEC standard damper actuators has been developed to operate and position air dampers of different sizes. Angular positioning of modulating actuators can be controlled by the NPG-1 positioner.

Product Features

- Torque 10 Nm
- Damper size 2.0 m²
- Power Supply AC/DC 24 V
- Control Modulating DC 0(2)...10 V and 0 (4)...20 mA
- 1 adjustable auxiliary switch (SPDT)
- Shaft dimensions Ø 10 to 17 mm (new 20 mm) round / □ 5 to 12 mm (new 14 mm) square
- Minimum shaft length 45 mm
- Selectable direction of rotation
- Adjustable angle of rotation
- Actuator with 1000 mm cable connection
- Customer version on request

Model Selection Table

Torque	Running Time	Power Supply	Auxiliary Switch	Model / Type
10 Nm	100...150 sec	AC/DC 24 V ± 10%	No	NACM 1.1-10
10 Nm	100...150 sec	AC/DC 24 V ± 10%	1 x SPDT	NACM 1.1-10S1

Actuator Dimensions (mm)

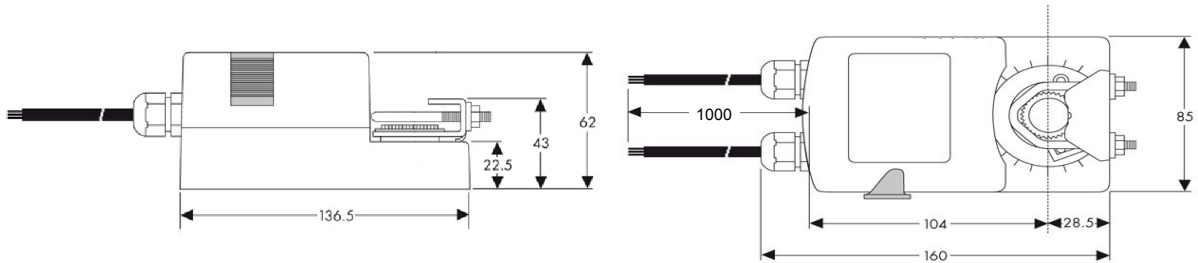

Technical Specifications

NACM 1.1...(S1)

Torque	10 Nm
Damper Size	2.0 m ²
Shaft dimensions	Ø 10 to 20 mm round / □ 5 to 14 mm square
Power Supply	AC/DC 24 V ± 10%
Frequency	50 - 60 Hz
Control Signal (Input)	DC 0(2)...10 V or 0(4)...20 mA
Position Signal (Output)	DC 0...10 V
Power Consumption	
- Operating	6.0 W
- End Position	2.0 W
For Wire Sizing	6.5 VA
Protection Class	III
Angle of Rotation	0°...90° (95° mechanical)
Angle of Limiting	0°...90° in 10° steps
Weight	< 1.0 Kg
Life Cycle	60'000 rotation
Sound Level	40 dB (A)
IP Protection	IP 54 (dust protected & protected against splash water)
Operating Temperature	-20°...+50° C / IEC 721-3-3
Non-Operating Temperature	-30°...+60° C / IEC 721-3-2
Ambient Humidity	5%...95% rH non condensing / EN 60730-1
Maintenance	Maintenance free
Mode of Operation	Type I / EN 60730-1
EMC	CE according to 89 / 336 / EEC
Auxiliary Switch Rating	3 (1.5) A, AC 250 V

Wiring Diagram NACM 1.1...(S1) Power Supply AC/DC 24 V

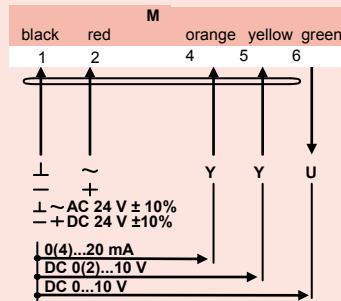

Changing Direction of Rotation NACM 1.1...(S1)

Factory-set CW!

The direction of rotation can be changed by pushing the CW/CCW switch on the actuator's housing.

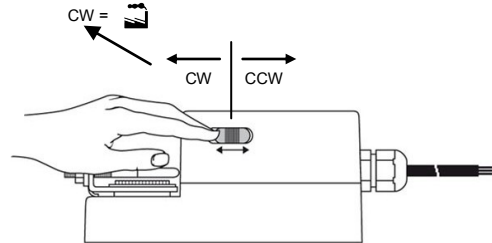

Adjustment of Control Signal NACM 1.1...(S1)

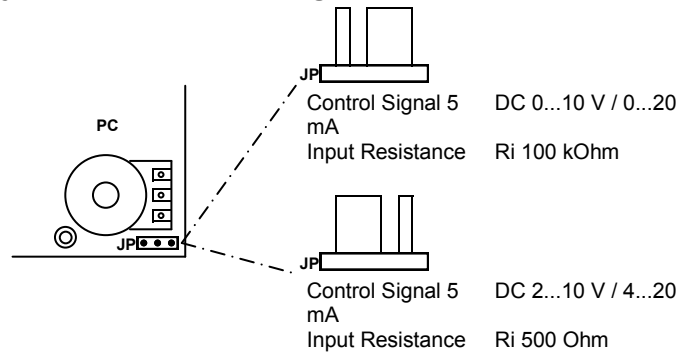

Wiring Diagram NACM 1.1...(S1) Auxiliary Switch

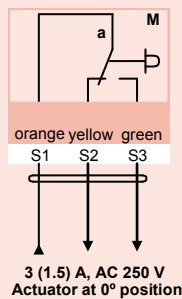

Adjustment of Auxiliary Switch NACM 1.1...(S1)

Switch a factory-set at 5°

The auxiliary switch can be optimally adjusted between 0°...90°.

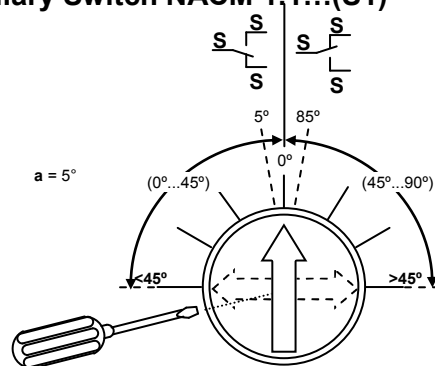

Wiring Diagram NACM 1.1...(S1) Parallel Connection

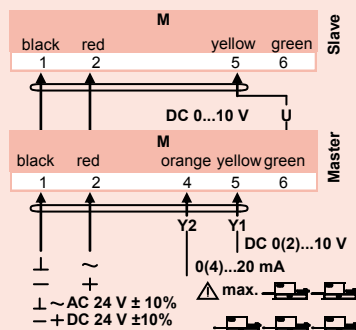

Remark

When NACM... (S1) actuators operate in parallel, the output signal U = DC 0...10 V (terminal 6) of the master actuator must be connected to terminal 5 of the next slave actuator.

The power consumption must be observed.

Releasing the Adapter NACA 1/2...(S1)

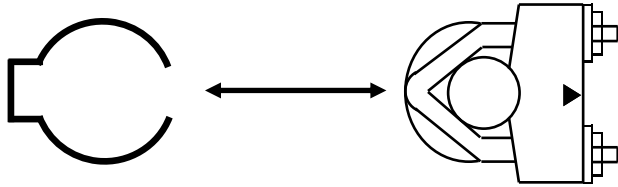

Limiting Angle of Rotation NACA 1/2...(S1)

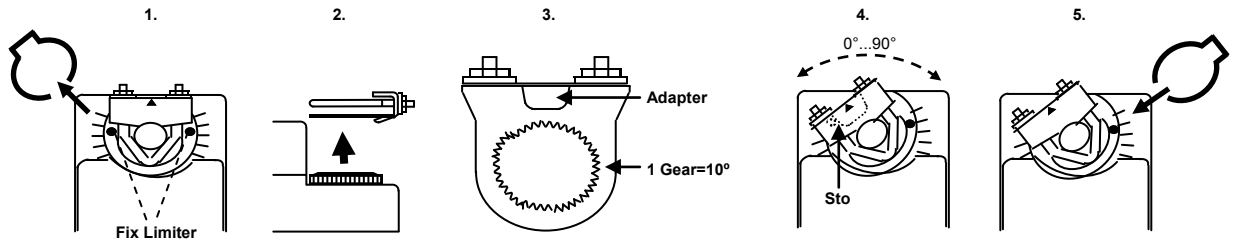

OEM Customised Version on Request

TELIMA/NENUTEC offers you actuators in customised versions, e.g. with your own brand name, with colour-coordinated applications and with your particular demand. Please contact us for further information.

Important Remark

Consult NENUTEC representatives for specific requirements and material selections for your intended application.



This actuator includes electrical and electronic components and may not be disposed as household garbage. Please consider the local valid legislation.



AC / DC 24 V: Connect via safety isolating transformer.
 AC 230 V: To isolate from the main power supply, the system must incorporate a device which disconnects the phase conductor (with at least a 3 mm contact gap).

Main Office :

NENUTEC®

NENUTEC ASIA PACIFIC PTE LTD
 7030 Ang Mo Kio Ave 5 #08-55
 Northstar@AMK
 Singapore 569 880
 Phone : +65 6570 3233
 Fax : +65 6570 6783
 Email : info@nenutec.com.sg
 Website : www.nenutec.com.sg

Headquarter:



TELIMA AG

Schachenstrasse 80
 CH-8645 Jona / Switzerland
 Phone : +41 55 212 40 60
 Fax : +41 55 212 40 69
 Email : info@telima.ch
 Website : www.nenutec.com